

SPINNAKER
DUMAS
GMT AUTOMATIC

GMT AUTOMATIC

This timepiece is equipped with a GMT dual time movement. It incorporates an individually controlled 4th hand that records time in a separate timezone using the 24 hour markings found on the turning bezel.

For more details on operating this timepiece please refer to the enclosed booklet or visit:

spinnaker-watches.com

SPINNAKER
DUMAS
GMT AUTOMATIC

Instruction Manual



For more information
Pour plus d'informations
Para más información
Per maggiori informazioni
Für mehr Informationen
想要查询更多资讯
詳細については

Vol. 1.119 EN

PLEASE READ THE FOLLOWING BEFORE UNSCREWING THE CROWN

Screw-down Crown

Screw-down crowns are used to ensure water resistance. **ALWAYS** be certain that your crown is securely screwed down (Position [0] is secured. Positions [1],[2] and [3] are not secured for water resistance). Do **NOT** unscrew your crown while you are in any environment where moisture is present.

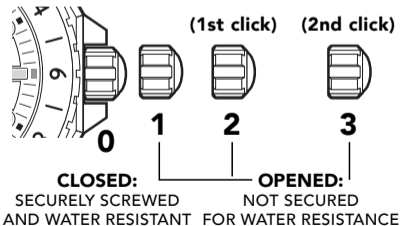
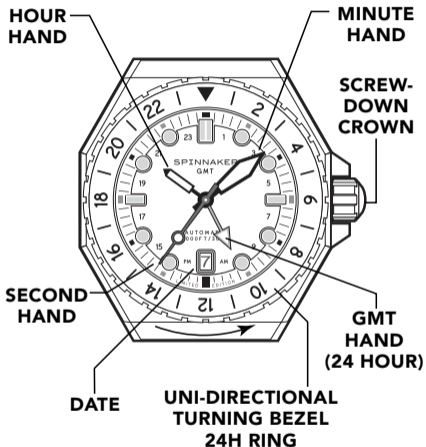

USING THE SCREW-DOWN CROWN

Do **NOT** pull the crown unless it is UNSCREWED first:

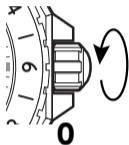

TO UNSCREW: Turn the crown anti-clockwise until it turns freely without tension. GENTLY pull the crown out to the other desired positions for watch setting (see specific operating instructions on the following pages).

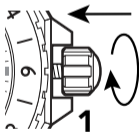

TO SCREW: Push the crown ALL THE WAY IN (towards the watch) THEN begin to turn clockwise until it is securely screwed down.

NOTE: Failure to SECURELY screw down the crown after setting the watch may affect its water resistance.

Before you use this watch, It is recommended that you manually wind the mainspring to start it moving.

THIS WATCH IS AN AUTOMATIC WATCH EQUIPPED WITH A MANUAL WINDING MECHANISM.

WINDING THE MAINSPRING

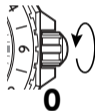

1. Unscrew the crown by turning it anti-clockwise.

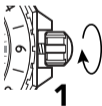

2. When it is in position [1] -(2nd click), turn the crown clockwise to wind. Wind 15-20 times and it will start to move naturally after shaking slightly.

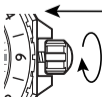

3. Push the crown in then screw it securely.

- * This watch **MUST** be worn for at least 8 (Eight) hours each day to ensure it is fully wound.

An automatic watch will only wind when the watch is on your wrist and your arm moves. Winding the watch by the crown will put power on the spring but not enough to allow the watch to function fully.

If your watch stops overnight or loses time it means it is not being fully wound.

IMPORTANT NOTE

1. If your watch is running smoothly, please do not wind the crown to avoid overwinding the movement. Provided you are wearing the watch frequently, your watch should have sufficient power to operate without any fuss.
2. If your watch has stopped running after a period of not wearing the watch, gently move the watch side to side 20 to 30 times to move the rotor or gently turn the crown 5 to 10 times to get the second hand run at its normal speed.

HOW TO SET THE TIME

1. Unscrew the crown and pull it out to position **[3]**-(2nd click).
2. Turn the crown clockwise to set the correct time.
3. Push the crown in then screw it securely.

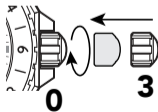
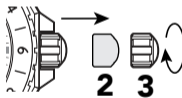
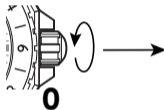

HOW TO SET THE DATE

1. Unscrew the crown and pull it out to position **[2]**-(1st click).
2. Turn the crown anti-clockwise to set the correct date.
3. Push the crown in then screw it securely.

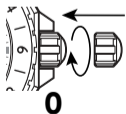
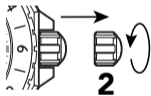
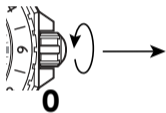

* Do not set the date between 9:00 P.M. and 4:00 A.M.

HOW TO SET THE SECOND TIME ZONE

1. Unscrew the crown and pull it out to position **[2]**-(1st click).
2. Turn the crown clockwise to set the correct time zone indication. (refer to the 24Hrs. marking on the dial).
3. Push the crown in then screw it securely.

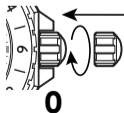
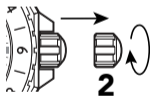
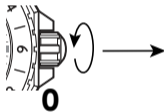

HOW TO READ A THIRD TIME ZONE

Your watch is equipped with a turning outer bezel calibrated with a 24 hour time zone marking.

With this, you can in fact read off a third timezone at a glance.

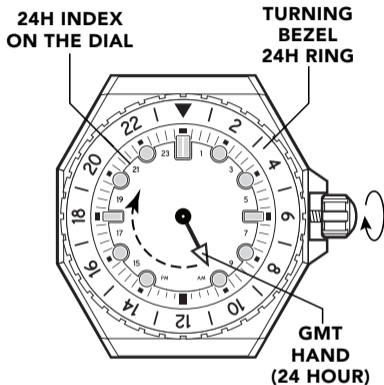

Time zone 1 or home time

This would be the normal time read off by the main hour and minute hands.

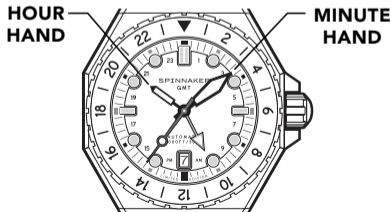

Time zone 2

By setting the independent GMT hand, you can read off a second timezone – off the fixed 24 hour markings on the dial.

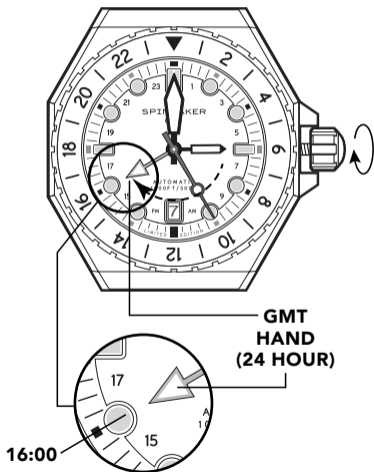

Time zone 3

By turning the BEZEL that operates the 24 hour ring you can align another timezone.

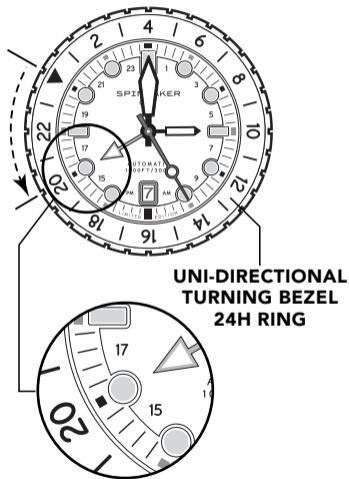

Example:

You are in **London** where the time is 3pm (15:00)

You would like to your GMT hand to read the time in **Dubai** (+4 from London)

Simply adjust your GMT hand to align it at the 19 position (19:00)

You would also like to keep an instant view of the time in **Hong Kong** (+4 from Dubai)

Turn the outer bezel so that the 19 and 23 align.

The time in **Hong Kong** will then be visible at a glance.

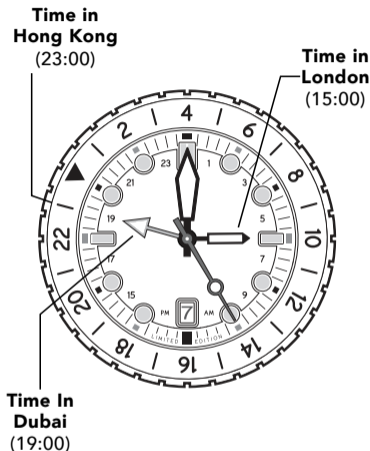

HOW TO CHANGE STRAPS WITH QUICK RELEASE SPRING BAR

1.

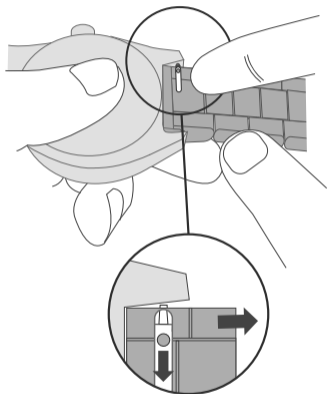

1. Use your finger to Push down the spring to release and remove the bracelet.

2.

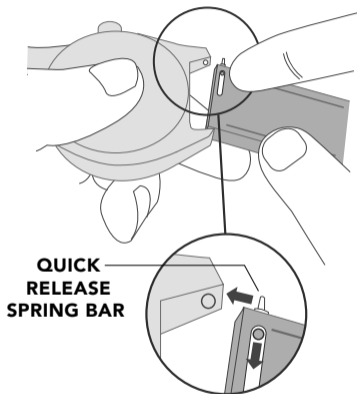

2. Use your finger to push down the spring so that the pin end reaches the hole for fastening.

HOW TO USE A DEPLOYANT CLASP

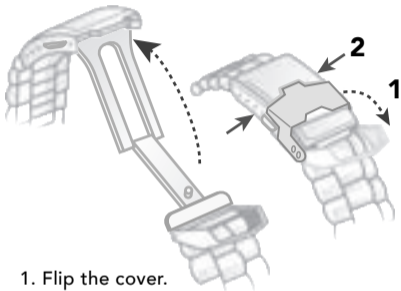

1. Flip the cover.

2. Press the buttons on the clasp sides.

HOW TO RESIZE METAL BRACELET

On the inside of the bracelet, you will see some small arrows engraved on removable links.

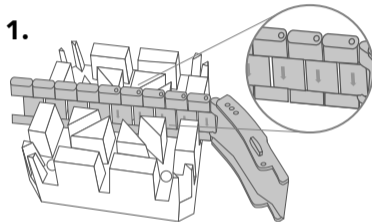

1.

2.

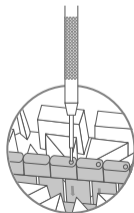

3.

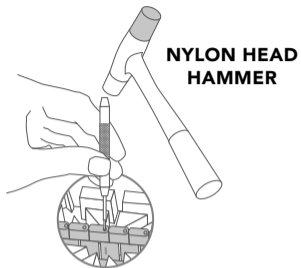

4.

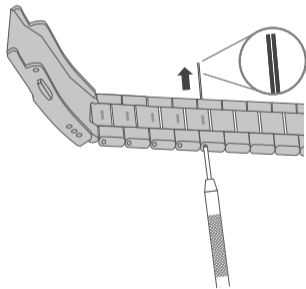

5.

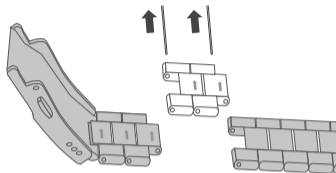

6.

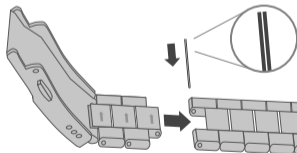

7.

**MICRO SIZE
ADJUSTMENT**

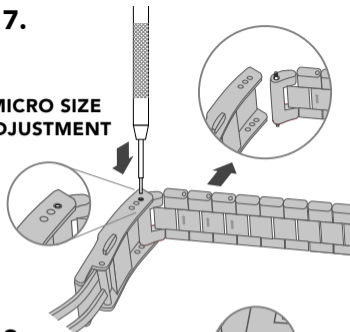

8.

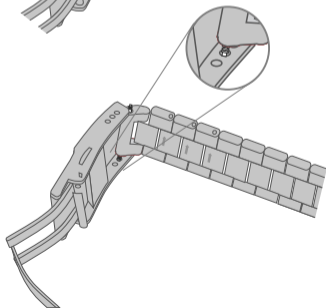

9.

10.

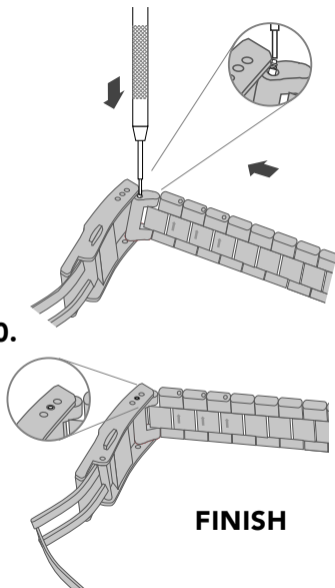

WATER RESISTANCE

Note that the water resistance chart serves only as a guide (please refer to the water resistance chart on the next page). Actual water resistance may vary depending on a number of factors including water temperature, water salinity and use under water.

The water resistance of your timepiece may eventually be compromised over time with general wear and tear and use of your timepiece under adverse conditions.

Always remember to employ the screw down crown if available to maintain the water resistance of your timepiece. Warranty may be voided if the screw down crown has not been properly employed.

Note that you should NEVER wear your watch in a jacuzzi, hot shower or steam room where steam may enter the case despite the watertight seals used to protect your watch.

This may cause condensation inside your watch, which may affect and damage the inner workings of your watch.

WATER RESISTANCE CHART	50M/ 5ATM	100M/ 10ATM	200M/ 20ATM	500M/ 50ATM	1000M/ 100ATM
SPLASH/ SHOWERING					
SWIMMING/ BATHING					
BRIEF SWIMMING/ WATER SPORTS					
PROLONGED SWIMMING/ FREE DIVING					
SCUBA DIVING					
PROFESSIONAL DEEP SEA DIVING					